

TECHNICAL DATA SHEET TRACK & SUPPLIES

KS RAIL

Product	Product reference
RAIL KS	KS

Suitable for discrete and silent ceiling laying

TECHNICAL INFORMATION :

Size: 15 x 20 mm
 Weight: 150 grams per meter
 Material: extruded aluminium
 Curtain maximum weight: 6 kg/ml
 Available colours (in stock): lacquered white / grey / black
 A slider every 10 cm approximately.

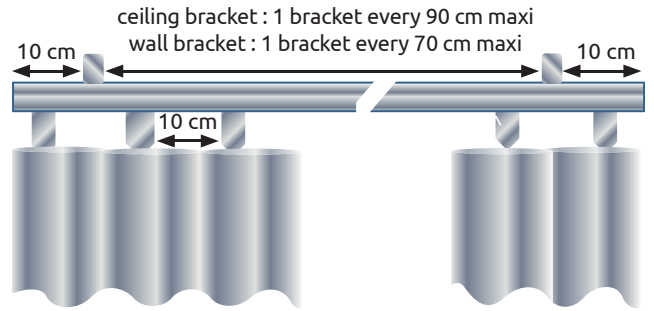

Lacquered white
RAL 9016



Lacquered grey
RAL 9005



Lacquered black
RAL 9006

STANDARD ASSEMBLY :

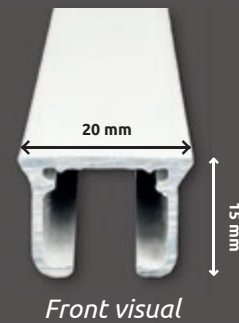
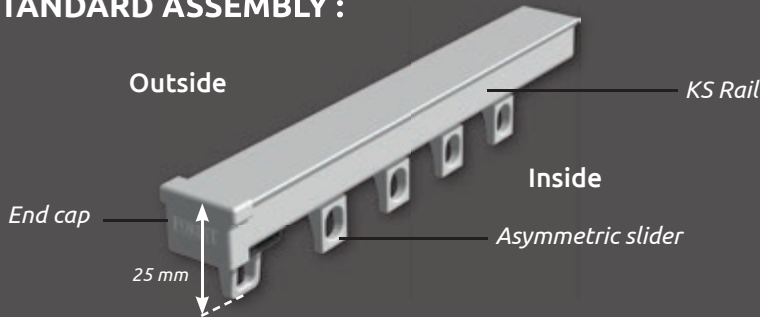

White
Ref. 795 501
(Ac)



Grey
Ref. 481 600 3000-A
(Fo)



Black
Ref. 481 600 6000-A
(Fo)



White
Ref. 791 501
(Fo)



Grey
Ref. 10 1000 3000
(Fo)



Black
Ref. 10 1000 6000
(Fo)

KS end cap

KS / DS asymmetric slider

Rail equipped with asymmetrical sliders: the sliders are directly above the edge of the curtain track.

OPTIONAL ACCESSORIES :



KS brake slider
Ref. 786 461



End track wall bracket KS + KSC
Left ref: 1016601
Right ref: 1016701



KS / DS rail splice
Ref. 737 161



False ceiling bracket
Ref. 104 005

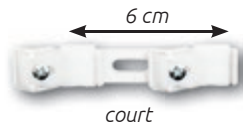

6 cm

Automatic ceiling bracket

short Ref. 1018611

long Ref. 1018601

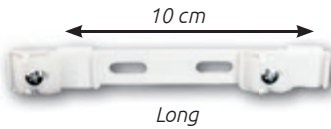

10 cm

Long



Clip ceiling bracket
Ref. 770 161 C



Overlap slider
Ref. 794 501

CEILING BRACKET :



Automatic ceiling bracket with cover (standard)



White
Ref. 785 161



Grey
Ref. 101 820 2000



Black
Ref. 101 820 6000

WALL BRACKET :

REINFORCED ALUMINIUM BRACKETS

Available in white, grey and black

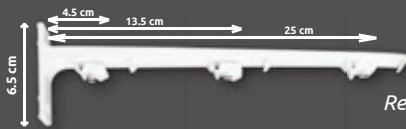

4.5 cm 13.5 cm 25 cm

Ref. 787 461 25

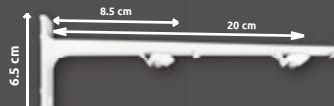

8.5 cm 20 cm

Ref. 787 461 20

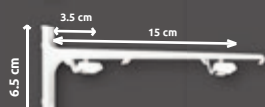

3.5 cm 15 cm

Ref. 787 461 15

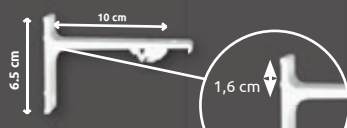

10 cm

(STANDARD)
Ref. 787 461 10



7.5 cm

Ref. 787 461 75

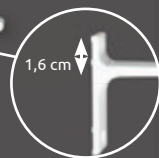

1,6 cm
Ceiling offset

STEEL BRACKETS

Available in white



15 cm

Ref. 786 161 150

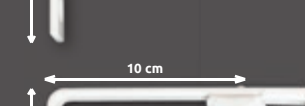

10 cm

(STANDARD)
Ref. 786 161 100



6 cm

Ref. 786 161 60



3 cm

Ref. 786 161 35

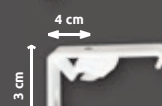

4 cm

ADJUSTABLE STEEL BRACKETS

Available in white



6,5 cm Max 10 cm

Double bracket
Ref. 102 080 1195



6,5 cm 4 cm

Simple bracket
Ref. 102 080 1115

CURVED KS TRACK : *The KS rail also exists as a curved rail with a 10CM BENDING RADIUS.*



The curved KS rail is used with the same accessories as the KS rail (seen previously on this technical data sheet).

Example of a curved KS rail with curtains + sheer:



3 POSSIBLE CONFIGURATIONS (WITHOUT SHEER):

Minimum length Rg and Rd: 15 cm

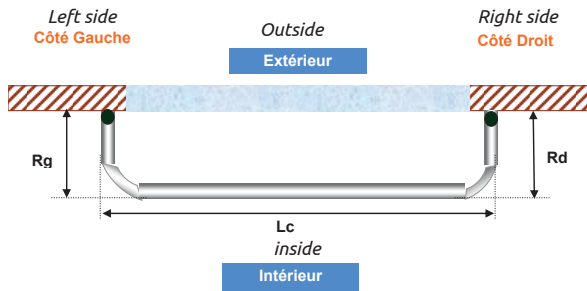

KS rail – 2 angles of 90°:
1 or 2 curtains

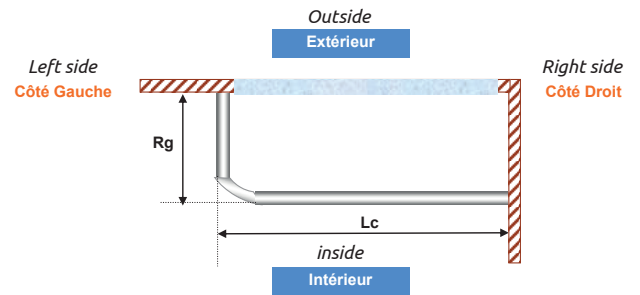

KS rail (BL) – 1 angle of 90° (Left side):
1 Curtain

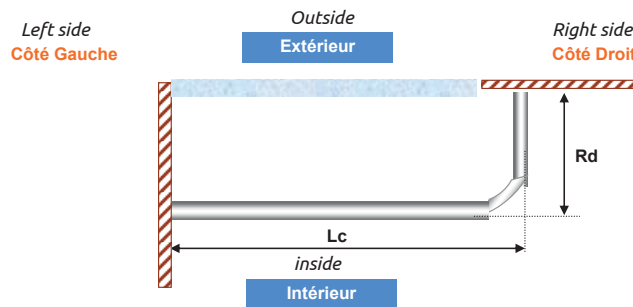

KS rail (BL) – 1 angle of 90° (Right side):
1 Curtain

3 POSSIBLE CONFIGURATIONS (WITH SHEER):

Minimum length Rg and Rd: 15 cm

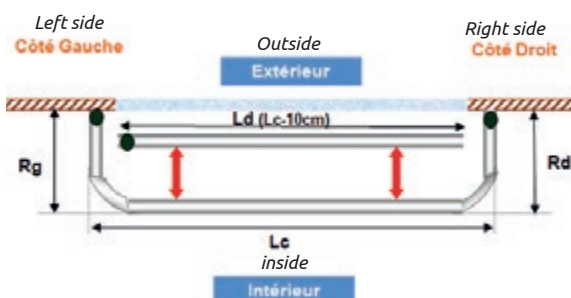

KS rail – 2 angles of 90°:
1 or 2 curtains + sheer

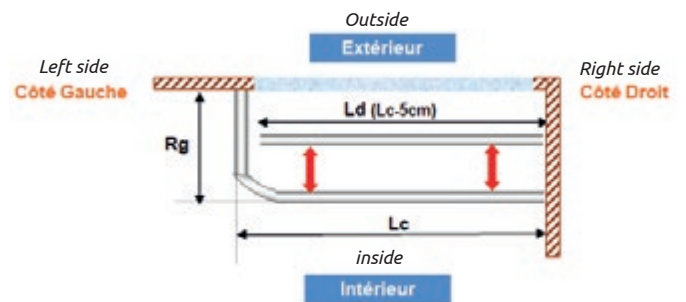

KS rail (BL) – 1 angle of 90° (Left side):
1 Curtain + sheer

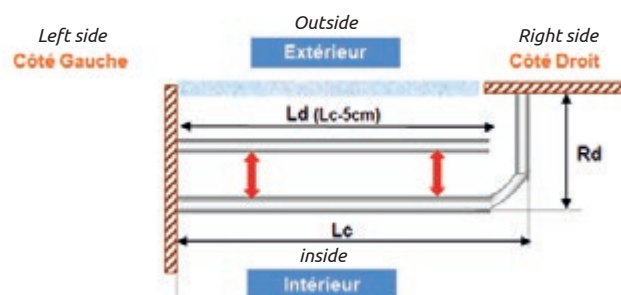

KS rail (BL) – 1 angle of 90° (Right side):
1 Curtain + sheer